



# Easiprox<sup>+</sup> Series

## Access Control Proximity Readers

### Easiprox<sup>+</sup>



### Easiprox<sup>+</sup> Slim



### Features:

- Applicable card mode :  
EM Card / Key Fob
- 1 Administrator and 200 Users
- 200 Proximity Cards / Key fobs
- Access Modes : Use Bluetooth smartphone or Card / Key fob to access
- Built-in Tamper alarm and Buzzer (85dB)
- User Management : Add / Delete / View user data, Grant user access for specific dates or time periods, Change user passcode
- Audit Trail logs for last 1000 events
- Alarm output to notify that Tamper alarm has been triggered
- Overhead LEDs for easy use in the dark

### Specifications:

- Operating Voltage : 12 VDC
- Bluetooth Module : BLE 4.2 Bluetooth Low Energy
- Current Draw :  
Standby current :  
36mA@12VDC  
Working current (Relay active) :  
42mA@12VDC
- Read Range : 5cm
- Frequency : EM 125KHz
- Operating Distance : Up to 50 meters (164 ft) without blocking by metal or concrete wall / door frames
- Smartphone Compatibility : Android 5.0 and up, iOS 9.0 and up
- Finish : ABS
- Temperature : -20 °C ~ 70 °C (-4 °F ~ 158 °F)
- Dimension / Color :  
Easiprox+ : 114 (L) x 80 (W) x 18 (D) mm / Navy Blue  
Easiprox+ Slim : 88 (L) x 44 (W) x 23 (D) mm / Black

# Easiprox<sup>+</sup> Series Pre-Installation

Please check Parts List :

## For Easiprox+ Series Parts



## For Easiprox+ Screw Packs



## For Easiprox+ Slim Screw Packs



## LED & Audible Indicators

LED	Status
Blue	Power on, Standby mode
Green	Unlocked, Door always unlocked
Red	Invalid access, Door always locked

Audible Beeps	Status
1 Long beep	Valid access, Reset is completed
2 Short beeps	Login completed
3 Short beeps	Invalid access
Constant beeping	Bluetooth device vandalized, Door sensor is on

## Easiprox<sup>+</sup> Series Wiring Diagram

(Easiprox+ & Easiprox+ Slim have same wiring and pin setting)

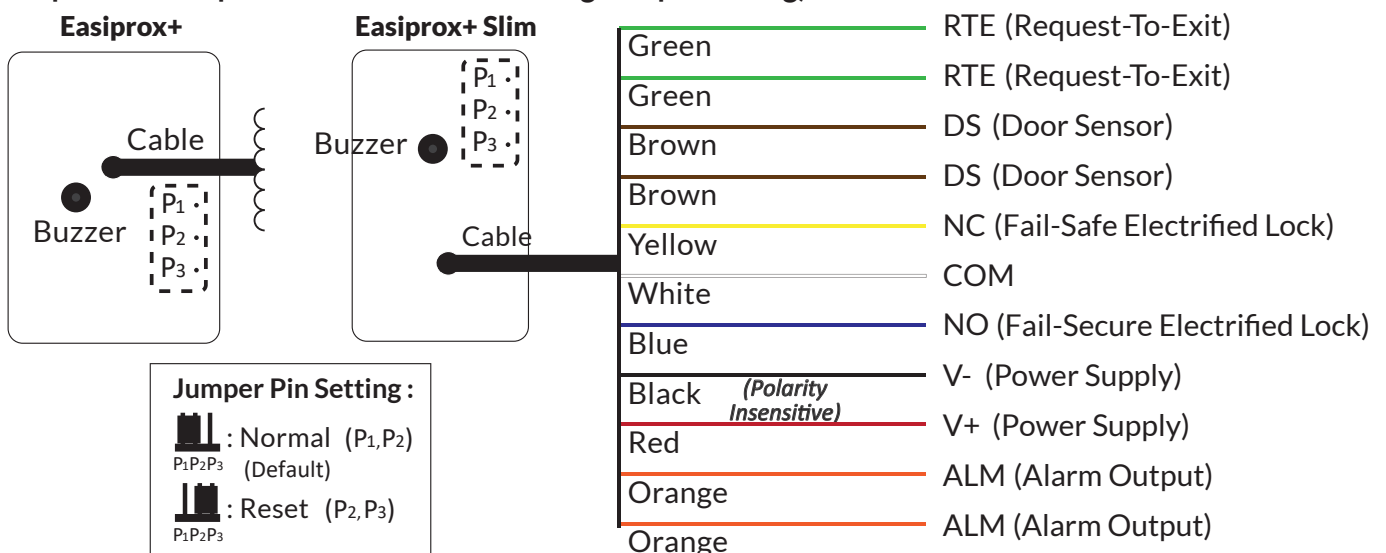

## Reset Procedures

1. Power off Access Control Reader.
2. Move the Pin Jumper to P2 and P3, then power on.
3. Hear a long beep to complete resetting procedures.
4. Move the Pin Jumper back to P1 and P2 to Normal setting.
5. Login as Admin and check all users, audit trail events are all cleared and everything is reset to factory default setting, except device name.

# Install Crimp Connectors

## Crimp connectors included:

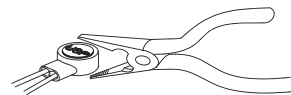

Crimp connectors



Use a pair of crimping pliers designed to crimp insulated connectors. Place the crimp connector into the compression slot. Be sure the crimping jaws are positioned over the stripped portion of the wire. Squeeze the handles together with enough force to crush the end of the butt splice.

## Easiprox<sup>+</sup> Reader Installation:

### Easiprox+

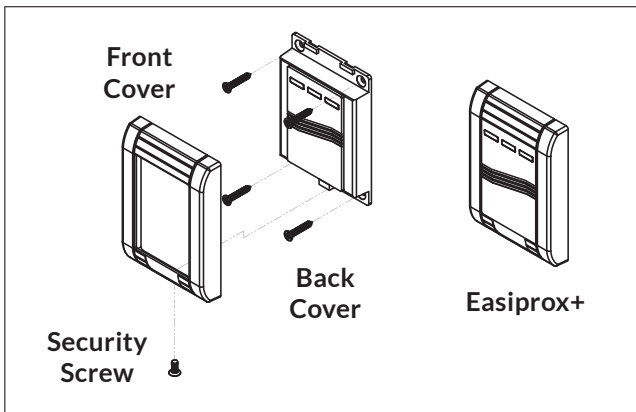

1. Check and measure dimensions.
2. Connect the wires and mount the back cover by using 4pcs of anchor screws into the wall.
3. Install the front cover then install the bottom security screw. Finish installation.

### Easiprox+ Slim

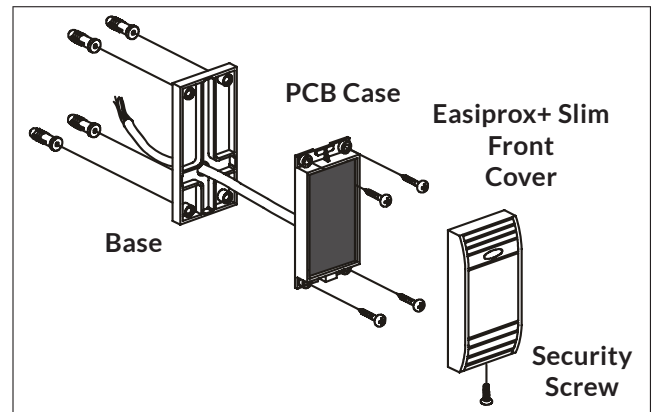

1. Check and measure dimensions.
2. Connect the wires and mount the base by using 4pcs of anchor screws into the wall.
3. Using 4pcs of screws to mount PCB case and the base.
4. Connect PCB Case and Front cover then install the bottom security screw. Finish installation.

## Software App Operations

### 1. Download Easiprox App (for model Easiprox+ Series and DG Series)



Easiprox

Download Easiprox App to set up. Scan QR Code on the left or download the App from Apple Store or Google Play depending on what kind of smartphone you use. Smartphone compatibility : Android 5.0 and up, iOS 9.0 and up

### 2. App Main Page Introduction

#### ① Login

**Administrator** : Enter Admin ID and Passcode to login.

**Admin ID** : ADMIN

**Default Admin Passcode** : 12345 (Passcode : 4~8 digits)

**User** : Enter User ID and User Passcode to login.

User ID and User Passcode are given by the Administrator.

#### [Note]

- 1.) Administrator ID "ADMIN" can not be changed. Please change Admin's default passcode "12345" right after you login as the Admin. Go to setting page, press Admin Passcode to Edit Admin Passcode.

#### 2.) Login Success / Login Failure indications will be shown as following :

Login Success : You Have Successfully Logged In. You May Now Unlock A Door.

Login Failure : Login Failed. Please Verify Your Login Information Or Contact Your Administrator.

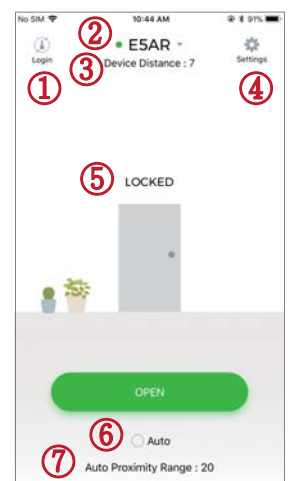

# Software App Operations

## ② Device name

Choose which device you want to unlock by pulling down the Device name listing.

## ③ Device distance

The distance between you and the Bluetooth Keypad/Reader.

## ④ Settings

Tap “Settings” to view or change setting functions.

## ⑤ LOCKED / UNLOCKED

LOCKED : Door lock status is Locked. (Default).

UNLOCKED : Press  button or the door icon  to unlock the door.

## ⑥ Auto

Press “Auto” to enable Auto unlock function to access.

Make sure to disable “Auto” before pressing  to enter Settings page.

## ⑦ Auto Proximity Range

Adjust Auto Proximity Range in Settings page. The range is between 0 to maximum 20 and it may have different results under different circumstances.

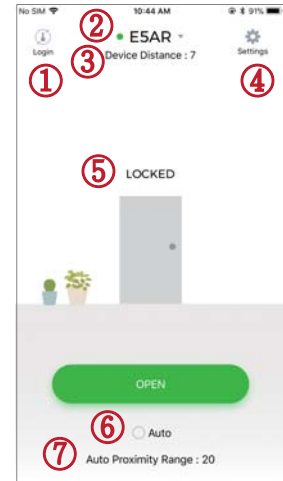

## 3. Administrator ” Settings” Page Introduction

Tap “Settings” to view or change setting functions in Users “Settings” Page.

### ① Users : (See Figure 1 below)

a. Add / Delete / Edit user information.

b. If there are many users, you can search User ID (Enter an User ID to search user).  
(See Figure 2 below)

c. ID (Up to 16 characters)

d. Passcode (4~8 digits)

e. Card / Fob number : Enter or Edit 10 numbers from a card or key fob.

f. Phone Access : Enable / Disable phone access for a user. (See Figure 3 below)

h. Keypad Access : Enable / Disable keypad access for a user. (See Figure 3 below)

g. Card / Fob Access : Enable / Disable Card and Key Fob access for a user.

(See Figure 3 below)

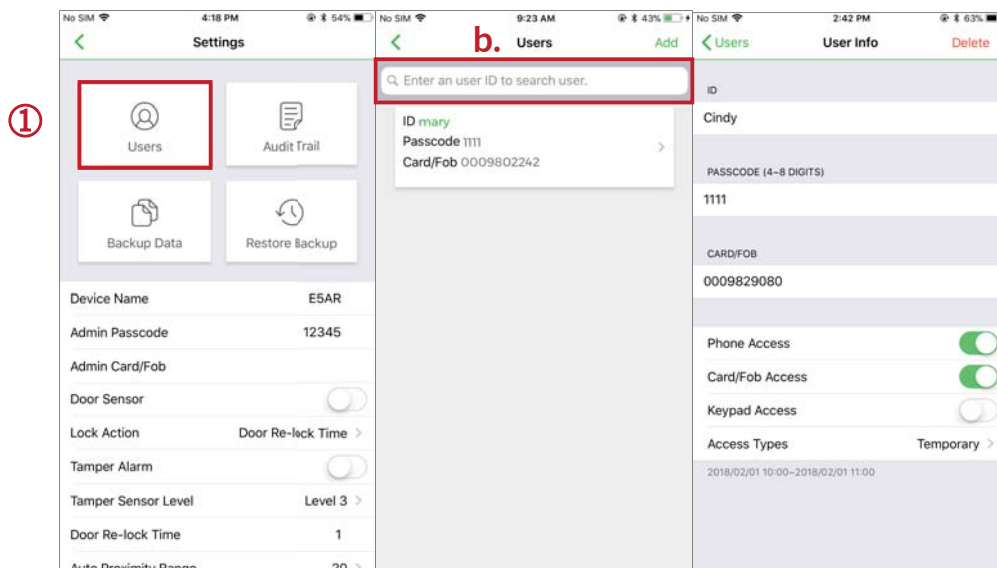

Figure 1

Figure 2

Figure 3

### i. Access Type : (4 options) (See Figure 4 below)

(A) Permanent : Permanent access is given by default.

(B) Temporary : Set specific access time period for guests and visitors.

(C) Number of Times : To set number of access granted to user.

(Please enter a number between 0 to 255)

(D) Scheduled : To assign repeatedly access on specific days and hours for a certain period of time. This setting is useful for house cleaners or constructors who need temporary access on regular basis. (See Figure 4 and 5)

### ② Audit Trail : (See Figure 6 and 7 below)

a. Audit Trail is tracking last 1000 event logs including Tamper Alarm.

b. Enter an user ID to search events for an user.

c. Tap  to export all events to excel file.

d. Tap  to refresh all events.

### ③ Backup Data : (See Figure 8 below)

Backup Data is to backup Users, Admin Passcode, Admin Card/Fob, Door Sensor, Lock Action, Tamper Alarm and Door Re-lock Time to Administrator's phone and can be restored except Device Name, Tamper Sensor Level, Auto Proximity Range, About Us and Audit Trail logs.

Step 1 : Press "Backup Data", the App will show :

Step 2 : Press Confirm, the App will show :

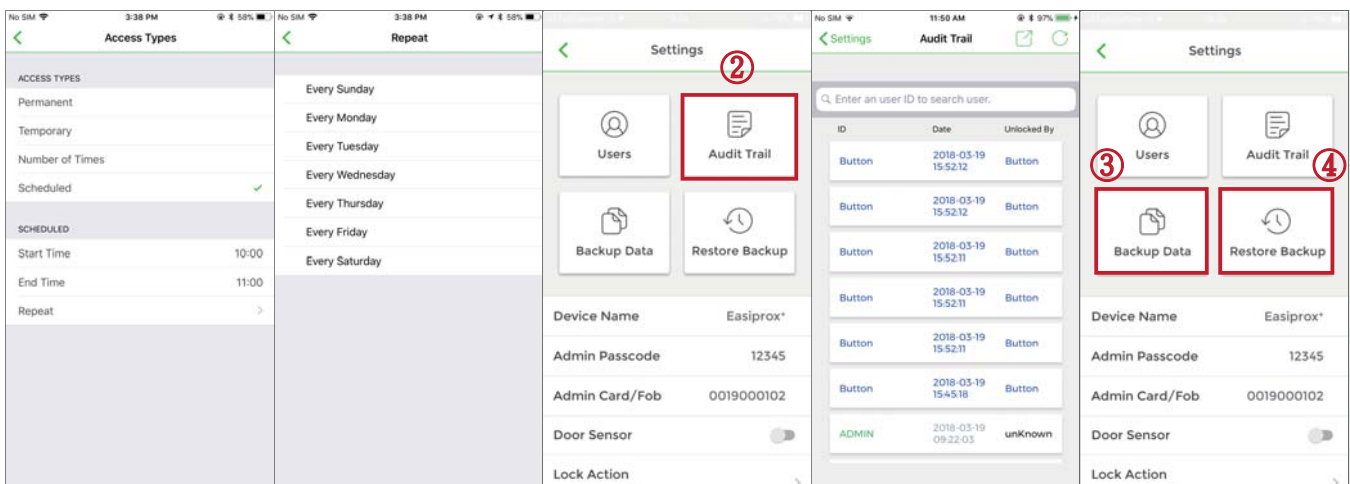

Figure 4

Figure 5

Figure 6

Figure 7

Figure 8

### ④ Restore Backup (See Figure 8)

Restore the last backup data by Admin's phone to a new Access Control Keypad / Reader.

Step 1 : Press "Restore Backup", the App will show :

Step 2 : Press Confirm, the App will show :

## Administrator " Settings" Page Introduction Continued : (See the Figure next page)

- **Device Name** : Edit Device Name (Up to 16 characters)
- **Admin Passcode** : Edit Admin Passcode (4~8 digits)
- **Admin Card/Fob** : Edit Admin Card/Fob number (10 numbers on your card or key fob)
- **Door Sensor** :  
Enable Door Sensor when you connect to a closed-circuit magnetic sensor or a monitored door lock that has door sensor (or lock sensor) outputs to monitor the open or closed state of a door.
- **Lock Action** : (3 options)  
Choose Door Re-lock Time, Door Always Unlocked, and Door Always Locked.

- **Tamper Alarm :**  
If the device is vandalized, the tamper alarm will beep immediately and won't go off until it's switched off by Administrator.
- **Tamper Sensor Level :**  
Level 1 (High Sensitivity)  
Level 2 (Mid Sensitivity)  
Level 3 (Low Sensitivity)
- **Door Re-lock Time :**  
6 seconds by default. Edit the Door Re-lock Time interval between 1 to 1800 seconds.
- **Auto Proximity Range :**  
Adjust Auto Proximity Range here. The range is between 0 to maximum 20 and it may have different results under different circumstances.
- **Device Time :**  
Make sure the Device Time is precisely synced with your current time zone to have correct and precise access data and information.
- **About us :** View Device Models, App version, Website and E-Mail information.
- **Firmware version :** See Firmware version of your Bluetooth Access Control Keypads/Readers.

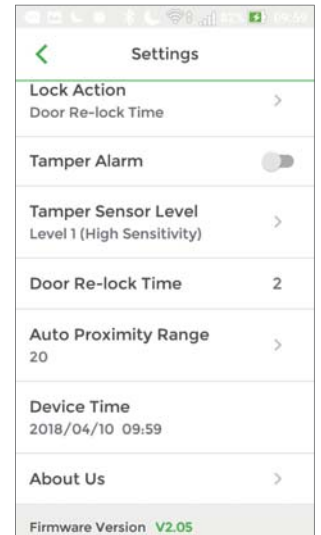

## 4. User's "Settings" Page Introduction

Tap "Settings" to view or change setting functions in User's "Settings" Page. (See Figure 9 below)

- Device Name : User can only view the Device Name. (See Figure 10 below)
- Auto Proximity Range : User can adjust Auto proximity range between 0 to maximum 20 to access. May have different results under different circumstances. (See Figure 11 below)
- About Us : View Device models, App version, Website information.

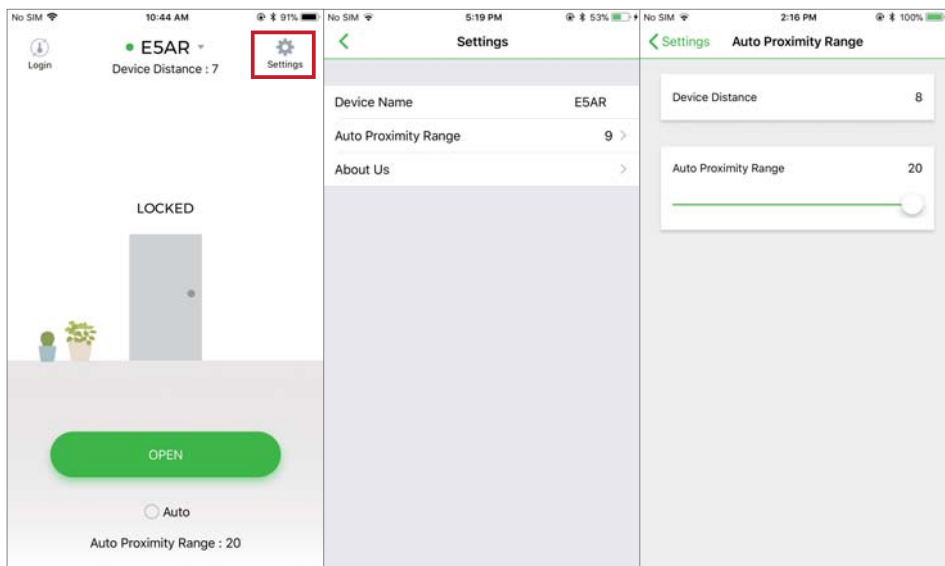

Figure 9

User's Settings Page  
Figure 10

Figure 11





## Warranty

---

This Gianni product is warranted against defects in material and workmanship while used in normal service for a period of one year from the date of sale. Gianni's obligation is limited to the repair or replacement of any defective part if the unit is returned, transportation prepaid, to Gianni. Warranty is void if damage is caused by or attributed to acts of God, physical or electrical misuse or abuse, neglect, repair, or alteration, improper or abnormal usage, or faulty installation, or if for any other reason Gianni determines that such equipment is not operating properly as a result of causes other than defects in material and workmanship.

## Notice

---

The information and specifications printed in this manual are current at the time of publication. However, the Gianni policy is one of continual development and improvement. For this reason, Gianni reserves the right to change specifications without notice. Copyright ©2018 Gianni Industries, Inc. All rights reserved. This material may not be reproduced or copied, in whole or in part, without the written permission of Gianni.

---

**GEM**<sup>®</sup> **GIANNI INDUSTRIES, INC.**  
No.13, Zhongxing Rd., Tucheng Dist., New Taipei City 23678, Taiwan (R.O.C.)  
**T** +886-2-2267-7986 **E** inquiry1@gianni.com.tw  
**F** +886-2-2267-9876 **W** www.gianni.com.tw Easiprox+\_Manual\_180913\_ver 1.0